

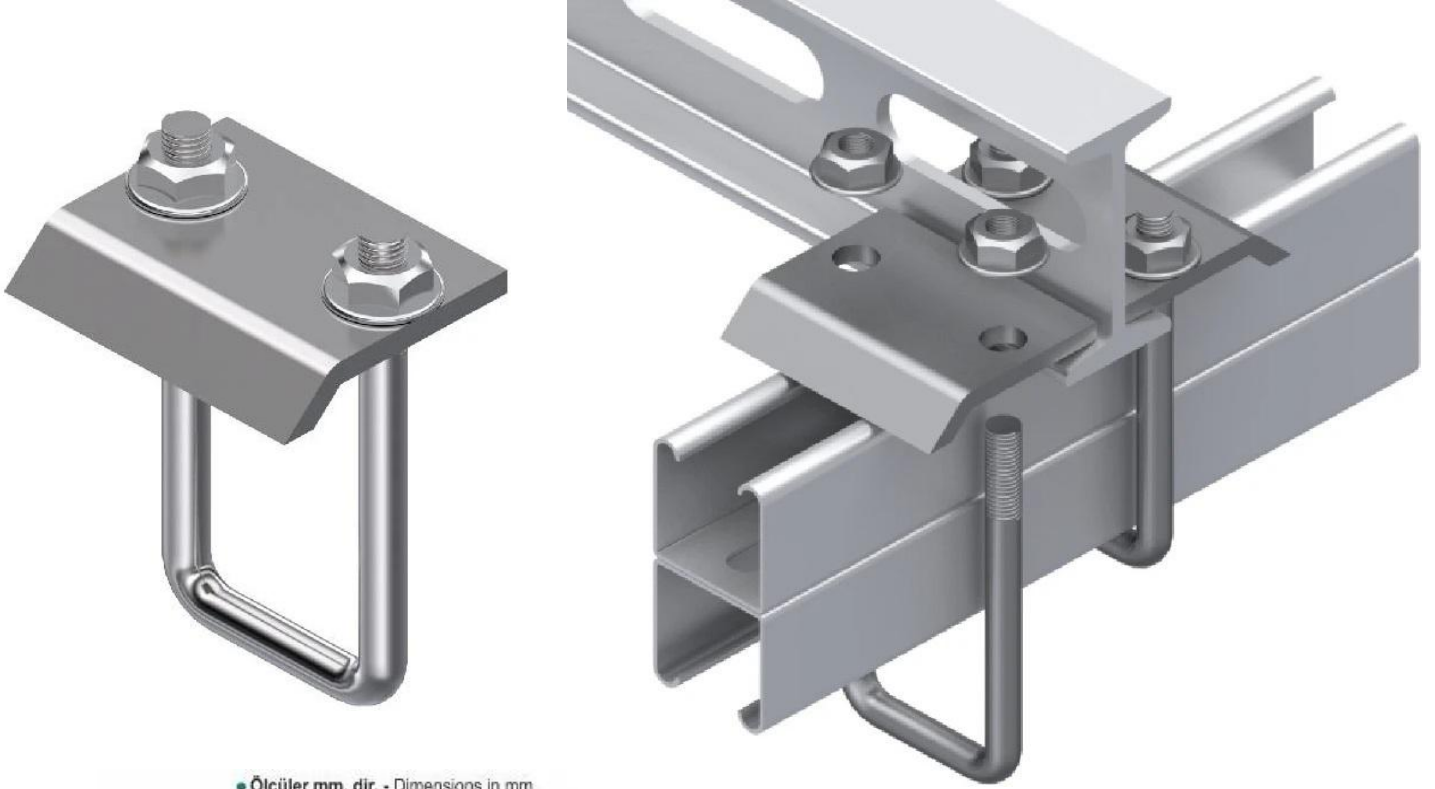

C Profil Montaj Elemanı STS-ECP2

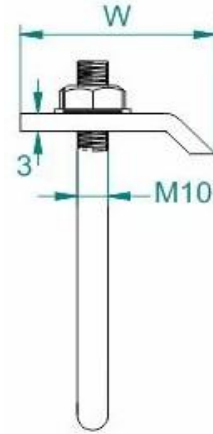

• Ölçüler mm. dir. - Dimensions in mm.

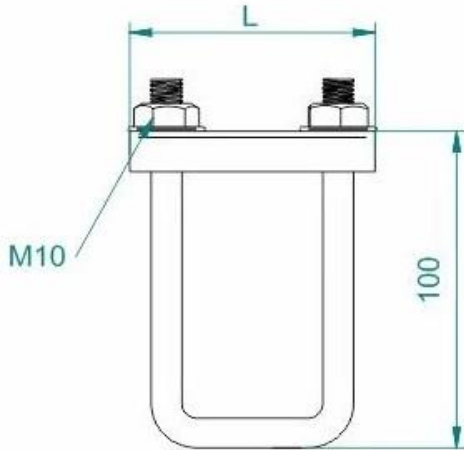

 Sıcak Daldırma Galvaniz - Hot Dip Galvanized

 Pregalvaniz - Pregalvanized

Ürün Kodu Product Code	W mm	L mm	 Kg ad/pce.	 Kg ad/pce.
STS ECP2	64	80	0,352	0,352

Yüzey Koruma

Sıcak Daldırma Galvaniz TS 914
Pre-galvaniz TS 822
Elektrostatik Toz Boya

Surface Protection

Hot Dip Galv. ISO EN 1461
Pre-galvanization ISO EN 10143
Electrostatic Spray Painting